

外視 / External view

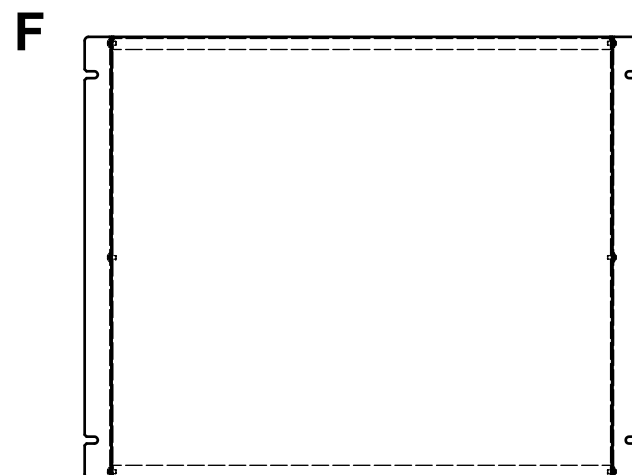

構成内容 / Components				
No.	名称 / Part name	数量 / Pcs	材質 / Material	色・表面処理 / Color・Finish
1	カバー Cover	1	ステンレス SUS304 t1.2 Stainless steel SUS304 t1.2	BA Polished-finish
2	シャーシ Base	1	ステンレス SUS304 t1.2 Stainless steel SUS304 t1.2	BA Polished-finish
3	取付ビス(トラスM3 x 5) Screw(Truss head M3 - 5)	6	ステンレス Stainless steel	無処理 Unfinished

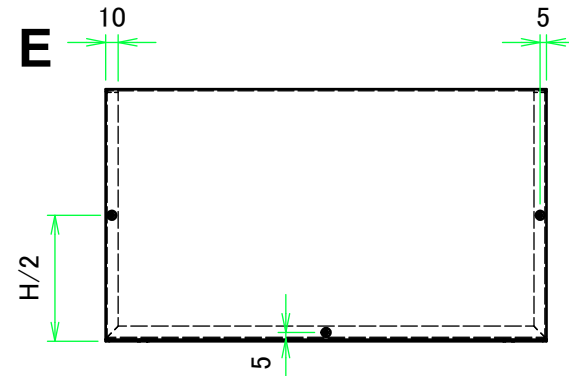
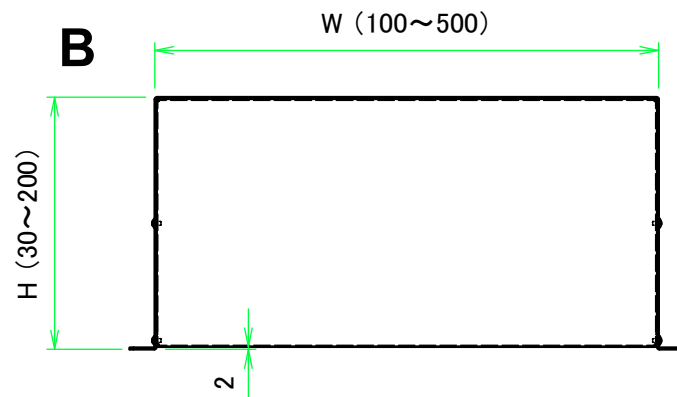
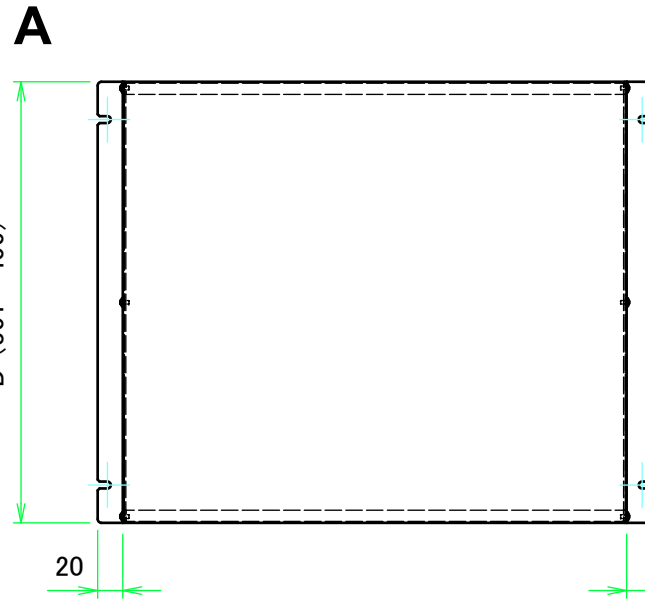
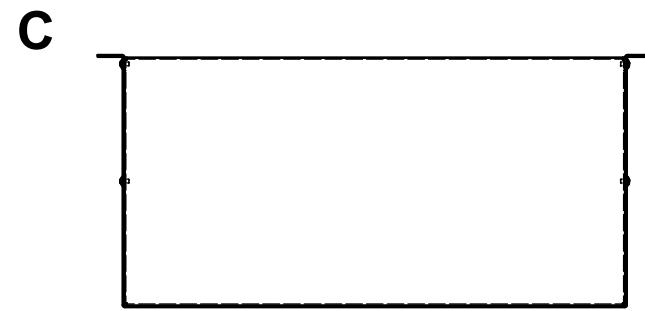
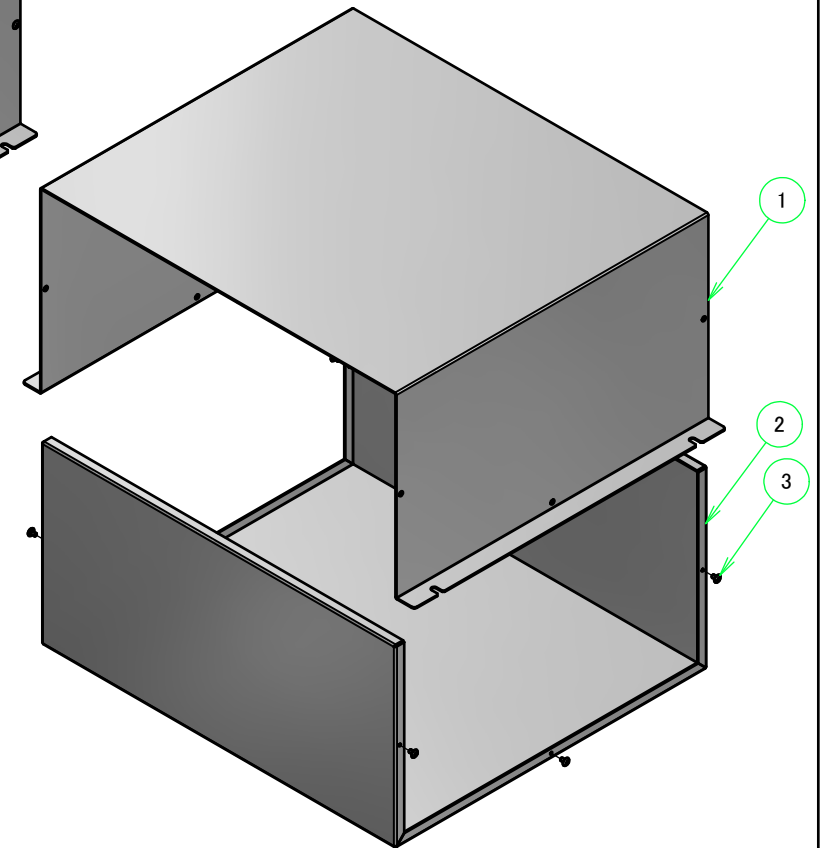
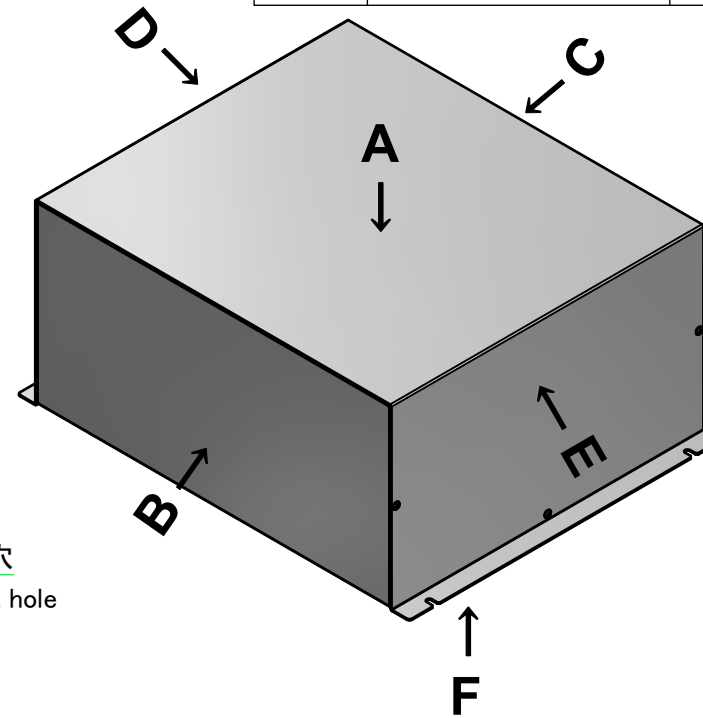

ケース型番 / Product Number

MBSF - - **B 12** - **4**

W H D シャーシタイプ・板厚 (補強あり・t1.2) 取付穴数 (mount hole)
Base type・thickness (reinforced・t1.2)

W・H・D 寸法制限範囲 / Dimension limit range		
W	H	D
100~500	30~200	301~400

* ケース寸法範囲内でも対応できない場合があります。詳細はカタログ内価格表でご確認ください。
* Size combinations available will vary based on each base type. For more information, refer to our catalog, or inquire.

株式会社タカチ電機工業 TAKACHI ELECTRONICS ENCLOSURE CO., LTD.			品名/Title フランジ足付ステンレスフリーサイズケース CUSTOM DIMENSIONS CASE	尺度/Scale 1 / 3
承認/Approved 中根	検図/Checked 大江	製図/Created 横田	型番/Product number MBSF□-□-□ B12-4(D≥301)	
			作成日/Date 2019/07/04	

カバー / Cover

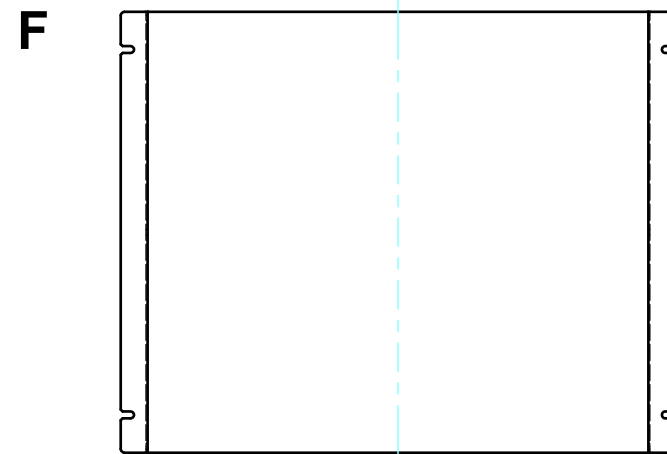
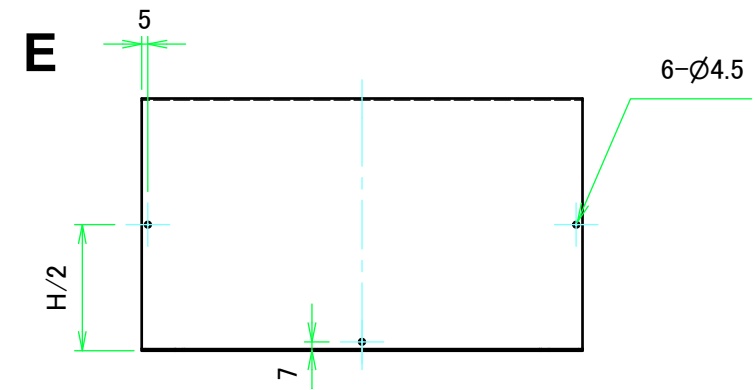
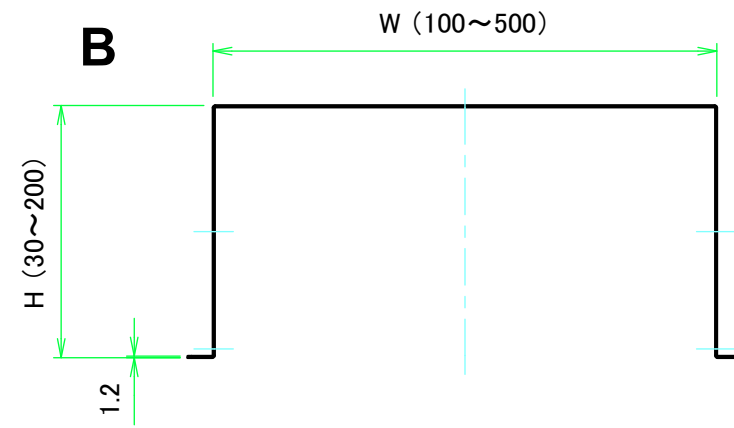
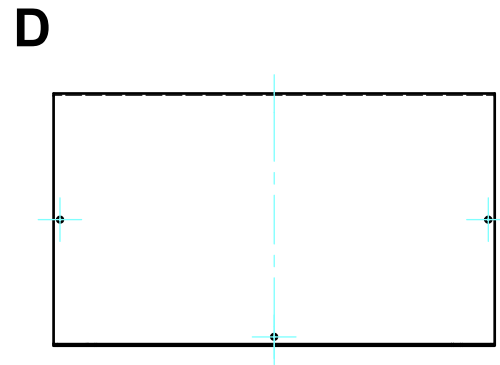
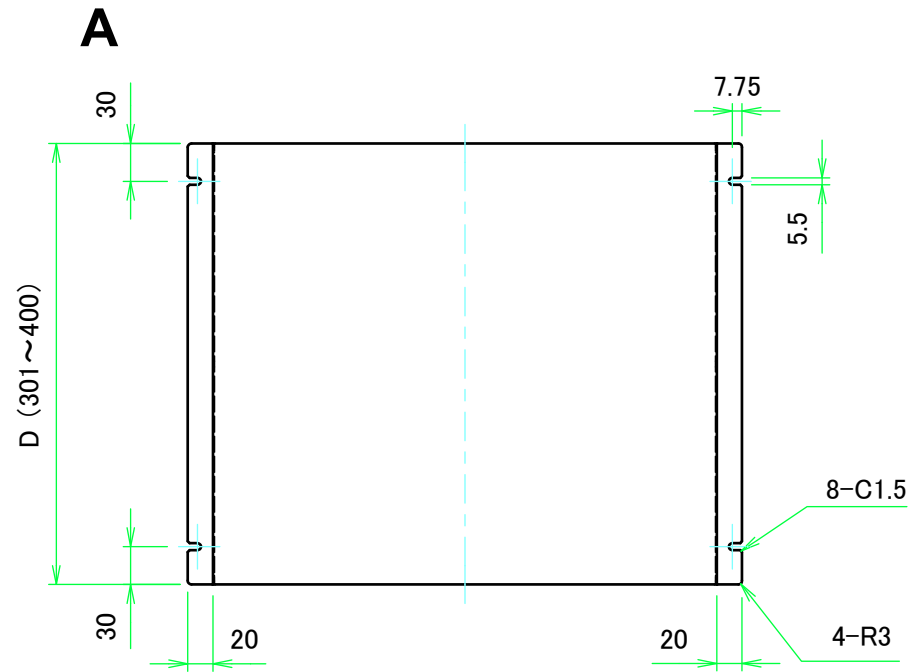
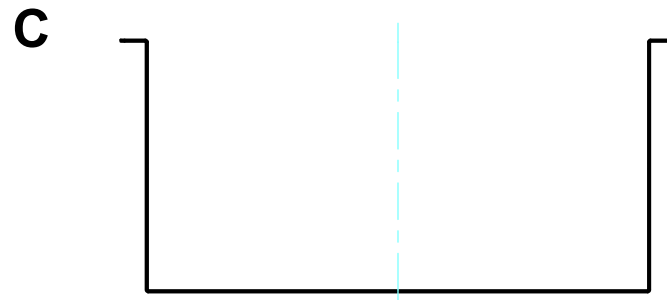

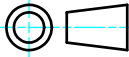
 株式会社タカチ電機工業 TAKACHI ELECTRONICS ENCLOSURE CO., LTD.			品名/Title フランジ足付ステンレスフリーサイズケース CUSTOM DIMENSIONS CASE	 尺度/Scale 1:6
承認/Approved 中根	検図/Checked 大江	製図/Created 横田	型番/Product number MBSF□-□-□ B12-4 (D≥301)	
			作成日/Date 2019/07/04	2 / 3

シャーシ / Base

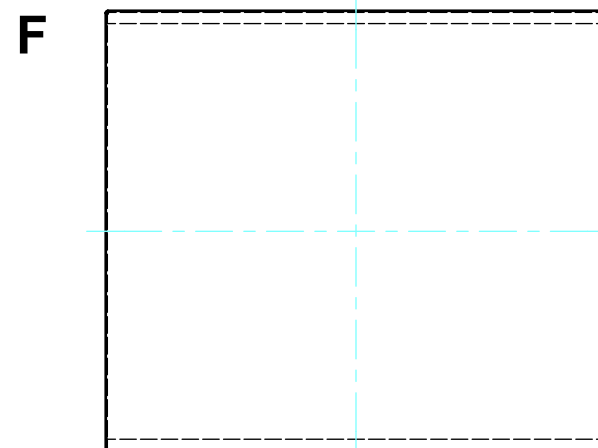
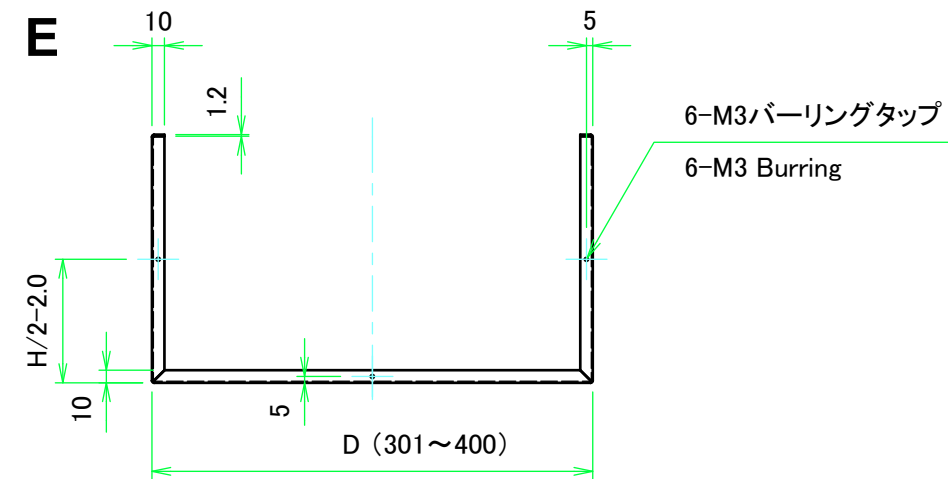
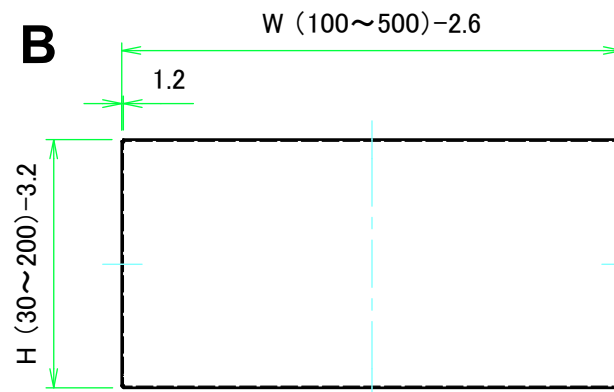
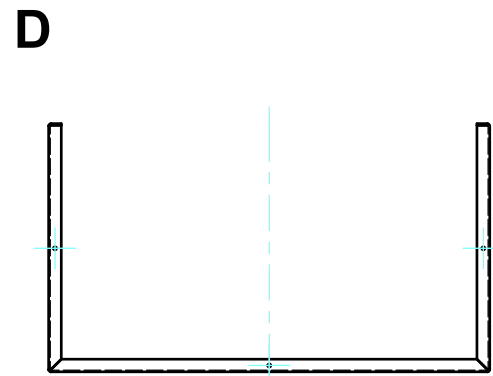
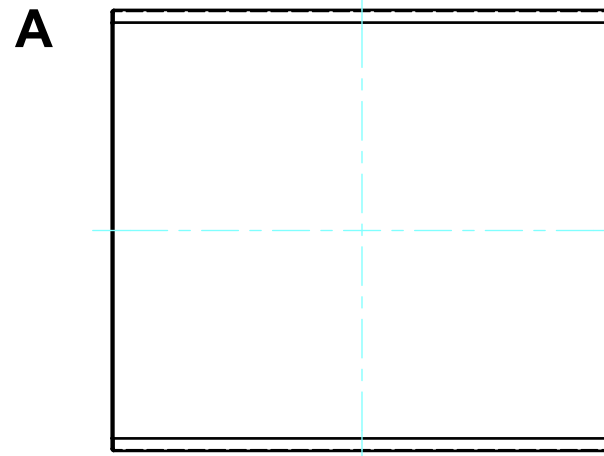

株式会社タカチ電機工業 TAKACHI ELECTRONICS ENCLOSURE CO., LTD.		品名/Title フランジ足付ステンレスフリーサイズケース CUSTOM DIMENSIONS CASE	尺度/Scale 1:6
承認/Approved	検図/Checked	製図/Created	
中根	大江	横田	作成日/Date 2019/07/04 3 / 3